

# Sec. 13

## OIL DRAIN PLUG GASKETS



### Steel With Rubber Seal Oil Drain Plug Gaskets

Auveco Part No.	I.D.	O.D.	Thick-ness	Unit Pkg.
16026	1/2"	1"	3/64"	5
18299	14mm	25mm	1mm	10
18931	16mm	24mm	2mm	10
18932	18mm	27mm	2mm	10



### Oil Drain Plug Rubber Gaskets

<p><b>21180</b> I.D. 11mm O.D. 18mm Replacement Gasket For Auveco No. 20347 Oil Drain Plugs Ford 1993 - On</p> <p>UNIT PACKAGE: 10</p> <p><b>18665</b> I.D.: 11mm O.D.: 21mm Replacement Gasket For Auveco No. 18663, 18664 &amp; 20372 GM 12mm-1.75 Oil Drain Plugs</p> <p>UNIT PACKAGE: 10</p> <p><b>20896</b> (Not Supplied By O.E.M.) I.D.: 13mm O.D.: 19mm Replacement Gasket For Auveco No. 19773 M14-1.5 Oil Drain Plugs</p> <p>UNIT PACKAGE: 10</p>	<p><b>21179</b> I.D. 11mm O.D. 19mm Replacement Gasket For Auveco No. 21047 Oil Drain Plugs GM 1985 - On</p> <p>UNIT PACKAGE: 10</p> <p><b>19630</b> I.D.: 11mm O.D.: 25mm Replacement Gasket For Auveco. No. 18023 GM 12mm-1.75 Oil Drain Plugs</p> <p>UNIT PACKAGE: 10</p> <p><b>20453</b> (F5TZ-6734-BA) I.D.: 13mm, O.D.: 22mm Replacement Gasket For Auveco No. 19279 M14-1.5 Oil Drain Plugs</p> <p>UNIT PACKAGE: 10</p>
---	--

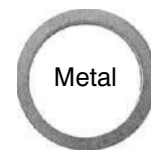
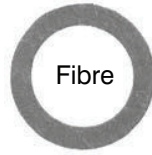

### Oil Drain Plug Gaskets

Auveco Part No.	I.D.	O.D.	Thick-ness	Mat.	Unit Pkg.
19538	1/2"	3/4"	5/64"	Bk. Fibre	50
8277	1/2"	3/4"	3/32"	Nylon	25
15918	1/2"	7/8"	1/16"	Copper	25
19590	1/2"	7/8"	1/16"	Aluminum	25
16996	1/2"	15/16"	1/16"	Nylon	25
18019	1/2"	15/16"	5/64"	Fibre	50
19539	9/16"	13/16"	5/64"	BK. Fibre	50
8281	9/16"	13/16"	3/32"	Nylon	25
15919	9/16"	13/16"	3/32"	Copper	25
8278	5/8"	1"	3/32"	Nylon	25
18021	3/4"	1"	1/16"	Copper	25
8279	3/4"	1-1/16"	3/32"	Nylon	25
18849	12mm	21mm	1.8mm	Steel*	5
16680	12mm	22mm	1.5mm	Nylon	50
19591	12mm	22mm	1.5mm	Copper	15
19601	12mm	22mm	1.5mm	Aluminum	50
18726	12mm	22mm	2mm	Bk. Fibre	50
17628	12mm	22mm	2.5mm	Bk. Fibre	25
19621	14mm	20mm	1mm	Aluminum	50
20454	14mm	20mm	1.5mm	Copper	15
19592	14mm	24mm	1.5mm	Copper	15
16956	14mm	22mm	2mm	Aluminum	50
16681	14mm	24mm	1.5mm	Nylon	50
16682	14mm	24mm	2mm	Gray Fibre	50
19604	16mm	22mm	1.5mm	Copper	10
19603	16.4mm	27mm	2mm	Bk Fibre	50
16683	16.5mm	27mm	1.5mm	Nylon	50
20462	18mm	24mm	1.2mm	Aluminum	25
16955	18mm	25.5mm	2mm	Aluminum	50
16684	18mm	29mm	1.5mm	Nylon	50
19605	18mm	26mm	1.5mm	Copper	10
18829	18mm	29mm	1.5mm	Grn Fibre	25
19139	20mm	26mm	2mm	Steel	15
16685	20mm	28mm	1.5mm	Nylon	50
19593	20mm	25mm	1.6mm	Copper	10
18830	20mm	28mm	1.5mm	Grn Fibre	25
21647	20mm	28mm	2mm	Bk. Fibre	25
21178	20mm	28.5mm	1.6mm	Aluminum	25
21648	23mm	29mm	2mm	Bk. Fibre	25
21649	24mm	30mm	1.8mm	Aluminum	10
18020	25.5mm	35mm	2mm	Bk Fibre	50

\* Teflon coated steel

### Oil Drain Plug Crushable Gaskets



Auveco Part No.	I.D.	O.D.	Thick-ness	Material	Unit Pkg.
19545	1/2"	3/4"	5/64"	Copper	10
17261	12mm	18mm	2mm	Copper	10
21258	12mm	18mm	3mm	Copper	10
19007	14mm	19mm	2mm	Steel	10
17262	14mm	20mm	2mm	Copper	10
21677	16mm	21mm	2.5mm	Steel	10
17263	16mm	22mm	2mm	Copper	10
17264	18mm	24mm	2mm	Copper	10
21116	18mm	24mm	2.5mm	Steel	10
17265	20mm	26mm	2mm	Copper	10

# OIL & TRANSMISSION DRAIN PLUGS (WITH GASKETS)

**Sec. 13**

## 14196

Plain

Thread: 1/2"-20  
Hex: 7/8"  
Length Under Head: 1/2"

Fits the following 1/2"-20 applications:

### AMC

6 & 8 Cyl. All 64-On

### Buick

4, 6 & 8 Cyl. All [Exc. 2.5 (151), 3.0, 4.3, 4.9 (301 Eng.)] 59-On

### Cadillac

6 & 8 Cyl. All (Exc. 4.1 Eng) 66-On

### Chevrolet (Includes Light Truck)

4, 6 & 8 Cyl. All [Exc. 1.8 (diesel), 2.5 (151), 4.3 (diesel) Eng.] 28-On

### Chrysler Corp.

6 & 8 Cyl. All 62-On

### Ford Motor Co.

4, 6 & 8 Cyl. All (Exc. 98, 122, 140, 171 Eng) 57-On

**GMC** (Light Truck) 6 & 8 Cyl. All 39-On

### Oldsmobile

4, 6 & 8 Cyl. All [Exc. 2.5 (151), 3.0, 4.3, (diesel), 4.3S, 4.9T (301)] 61-On

### Pontiac

4, 6, & 8 Cyl. All [Exc. 1.8 (diesel), 2.5 (151), 4.3 (diesel), 4.3S, 4.9T (301)] 60-On

UNIT PACKAGE: 10



## 18373

(6034376)

Plain With Rubber Washer Face Gasket

Thread: 1/2"-20  
Hex: 5/8"  
Length Under Head: 13/16"  
Rubber Gasket O.D.: 1-3/32"

Fits the following applications:

### Chrysler

UNIT PACKAGE: 2



## 20807

(F81Z-6730-AA)

Plain With Rubber Washer Face Gasket

Thread: M10-1.5  
Hex: 13mm  
Length Under Head: 15mm  
Rubber Gasket O.D.: 28mm

Fits the following 4R100 transmission applications:

**Ford** E150-450, F150-450 Excursion & Expedition 1980 - On

UNIT PACKAGE: 1



## 18022

(948187-0)

Zinc

Thread: 3/4"-16  
Hex: 1"  
Length Under Head: 1/2"

Fits the following applications:

**Volvo:** 4 Cyl.

UNIT PACKAGE: 2



## 15527

Zinc

Thread M12-1.25  
Hex: 14mm  
Length Under Head: 11mm  
Washer Head O.D.: 20mm

Fits the Following M12-1.25 applications:

### Nissan

Sentra, Stanza & Pulsar w/ FWD 1982-On

UNIT PACKAGE: 5



## 19130

(3921988)

Plain

Thread: 1/2"-20  
Hex: 9/16"  
Length Under Head: 13/16"  
Washer Head O.D.: 7/8"

### Buick

4, 6 & 8 Cyl. All [Exc. 2.5(151) 3.0, 4.3, 4.9 (301 Eng.)] 59-On

### Cadillac

6 & 8 Cyl. All (Exc. 4.1 Eng) 66-On

### Chevrolet (Inc. GMC Light Truck)

4, 6 & 8 Cyl. All [Exc. 1.8 (diesel), 2.5 (151), 4.3 (diesel) Eng.] 28-On

### Oldsmobile

4, 6 & 8 Cyl. All [Exc. 1.8 (diesel), 2.5 (151), 3.0, 4.3, (diesel), 4.3S, 4.9T (301)Eng.] 61-On

### Pontiac

4, 6 & 8 Cyl. All [Exc. 1.8 (diesel), 2.5 (151), 4.3 (diesel), 4.3S, 4.9T (301)Eng.] 60-On

UNIT PACKAGE: 15



## 21665

(BC3Z-6730-A)

Yellow Plastic With Rubber Gasket

Diameter: 13/16"  
3/8" Square Drive  
Overall Length: 1-13/16"

Fits The Following Applications:

**Ford** F250 & F350 with 6.7L Powerstroke 2011 - On

UNIT PACKAGE: 1



## 19589

Zinc

Thread M12-1.5  
Hex: 13mm  
Length Under Head: 12mm  
Washer Head O.D.: 17mm

Fits The Following Applications:

**BMW & Mercedes**

UNIT PACKAGE: 5



## 19318

(Jeep: 83504041;

Lexus: 90341-10006,

90341-10012)

Zinc & Yellow

Thread: M10-1.5; Hex: 14mm  
Length Under Head: 9mm  
Fits the following transmission applications:

**Jeep** Cherokee, Comanche & XJ 1991-On

**Lexus** GS300, LS400 & SC400 1991-On

UNIT PACKAGE: 2



## 21293

(11128-01MOB)

Zinc & Yellow

Thread: M12-1.25  
Hex: 14mm  
Length Under Head: 12mm  
Washer Head O.D.: 32mm

Fits the following applications:

**Nissan Sentra & 350Z and Infiniti** 1992 - On

UNIT PACKAGE: 2



**Sec. 13****OIL & TRANSMISSION DRAIN PLUGS (WITH GAS-KETS)****19588**

Zinc

Thread: M12-1.25

Hex: 14mm

Length Under Head: 17mm

Washer Head O.D.: 20mm



Fits The Following Applications:

**Nissan**

UNIT PACKAGE: 5

**21353**

(90009-PH1-000,

90009-PH6-000)

Zinc &amp; Yellow

Thread: M14-1.5

Hex: 17mm

Length Under Head: 10mm

Washer Head: 24mm



Fits the following applications:

**Acura & Honda**

UNIT PACKAGE: 5

**21352**

(N90288901)

Black Zinc

Thread: M14-1.5

Hex: 19mm

Length Under Head: 14mm



Fits the following applications:

**Volkswagen**

UNIT PACKAGE: 2

**21135**

(21512-23001)

Dacromet

Thread: M14-1.5

Hex: 17mm

Length Under

Head: 17mm

Washer Head O.D.: 22.5mm



Fits the following applications:

**Hyundai & Kia** 1995 - On

UNIT PACKAGE: 2

**18023**

(21006725)

Black Zinc

With Rubber

Gasket

Thread: M12-1.75

Hex: 14mm

Length Under Head: 19mm

Rubber Gasket O.D.: 31mm



Fits the following application:

**GM: Saturn**

UNIT PACKAGE: 2

**21093**

(24233099)

Zinc With

Rubber Gasket

Thread: M12-1.75

Hex: 15mm

Length Under Head: 20mm

Washer Head O.D.: 32mm



Fits the following applications:

4L80-E Transmissions on **Chevrolet**

2 WD Full Size Vans &amp; Pickup

Trucks 1997 - On

UNIT PACKAGE: 2

**18374**

(F5AZ-6730)

Plain With Rubber

Washer Face Gasket

Thread: M12-1.75

Hex: 15mm

Length Under Head: 21mm

Rubber Gasket O.D.: 28mm



Fits the following applications:

**Ford** 2.5, 3.0 & 4.6 Eng.

With Modular &amp; Aluminum Pans

UNIT PACKAGE: 2

**21354**

(6507741-AA)

Zinc With

Rubber Gasket

Thread: M14-1.5

Hex: 17mm

Length Under

Head: 21mm

Washer Hd O.D.: 29mm

Fits the following application:

**Chrysler**

UNIT PACKAGE: 2

**20347**

(YS4Z-6730AA)

Plain With

Rubber Gasket

Thread: M12-1.75

Hex: 13mm

Length Under Head: 25mm

Washer Head O.D.: 26mm

Fits the following applications:

**Ford** 1999 - 93

UNIT PACKAGE: 2

**21047**

(GM: 3536964,

3538469, 11519408,

11562588, 24100042;

Isuzu: 8-11519-408-0)

Zinc With

Rubber Gasket



Thread: M12-1.75

Hex: 15mm

Length Under Head: 25mm

Washer Head O.D.: 26mm

Fits the following applications:

**GM** 2.2 (4), 3.1 (M), 3.8 (K), 3.8 (1),

2.3, 4.9 &amp; 6.0L Eng. 1985 - On

UNIT PACKAGE: 2

**14677**

Zinc

Thread: M12-1.75

Hex: 15mm

Length Under

Head: 26mm

Washer Head O.D.: 22mm



Fits the following

M12-1.75 applications:

**Buick**

4 Cyl. 151 (2.5) Eng. 80-On

6 Cyl. 3.0, 4.3 (Diesel) Eng. 82-On

8 Cyl. 4.3, 4.9 Eng. 81-77

**Cadillac**

8 Cyl. 4.1 Eng. 82-On

**Chevrolet**

4 Cyl. 151 (2.5) Eng. 78-On

6 Cyl. 4.3 (Diesel) Eng. 82-On

**Oldsmobile**

4 Cyl. 151 (2.5) Eng. 78-On

6 Cyl. 3.0, 4.3 (Diesel) Eng. 82-On

8 Cyl. 4.3S, 4.9T (301) Eng. 80-79

**Pontiac**

4 Cyl. 151 (2.5) Eng. 77-On

6 Cyl. 4.3 (Diesel) Eng. 82-On

8 Cyl. 4.3S, 4.9T (301) Eng. 81-77

UNIT PACKAGE: 5

# OIL & TRANSMISSION DRAIN PLUGS (WITH GASKETS) **Sec. 13**

## 18024

Zinc

Thread: M14-1.25  
Hex: 13mm  
Length Under Head: 16mm  
Washer Head O.D.: 23mm

Fits the following applications:  
**Jeep**

UNIT PACKAGE: 5



## 18025

(E9DZ-6730-B)  
Zinc

Thread: M14-1.5  
Hex 13mm  
Length Under Head: 16mm  
Washer Head O.D.: 23mm

Fits the following applications:  
**Ford: Escort**

UNIT PACKAGE: 5



## 19773

(F75Z-6730-BA)  
Phosphate With  
Rubber Gasket

Thread: M14-1.5  
Hex: 16mm  
Lgth Under Hd: 20mm  
Washer Hd O.D.: 28mm

Fits the following applications:  
**Ford Vans & Trucks**  
With 6.8L Eng. 2000-96

UNIT PACKAGE: 1

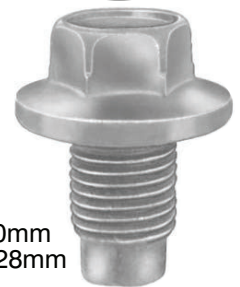

## 16308

Zinc

Thread: M14-1.5  
Hex: 16mm  
Length Under Head: 11mm  
Washer Head O.D.: 25mm

Fits The Following  
M14-1.5 Applications:  
**Chrysler Imports 83-On**

**Honda 83-On**

**Isuzu 87-On**

**Mazda 72-On**

**Spectrum 88-On**

**Sprint 88-On**

**VW-Audi 74-On**

UNIT PACKAGE: 5



## 18375

(6503433)

Plain With  
Rubber Washer  
Face Gasket

Thread: M14-1.50  
Hex: 17mm  
Length Under Head: 18mm  
Rubber Gasket O.D.: 28mm

Fits the following applications:  
**Chrysler 1.5 & 2.0 Eng.**

UNIT PACKAGE: 2



## 19279

(F6TZ-6730BA)  
Phosphate  
With Rubber Gasket

Thread M14-1.50  
Hex: 13mm  
Lgth Under Hd: 20mm  
Washer Hd O.D.: 28mm

Fits the following applications:  
**Chrysler** with 2.0(F), 2.4(B,G,8),  
2.7(R,T), 3.3(G,S,3) & 3.5(G,4)  
Eng. 2000 - On

**Ford Aerostar, Explorer & Ranger**  
6 Cyl. 4 Ltr. Eng. 1996-On

UNIT PACKAGE: 2



## 20746

(N90813201)

Zinc With  
Sems® Gasket

Thread: M14-1.5  
Hex: 19mm  
Length Under Head: 20mm  
Sems® Washer O.D.: 20mm

Fits the following applications:  
**Audi** Cabriolet & Quattro with 1.8,  
1.9, 2.0, 2.7, 2.8, & 3.0 Eng.  
**VW** Beetle, Eurovan, Golf, Jetta,  
Passat & Touareg with 1.8, 1.9, 2.0,  
2.8, 3.2 & 4.0 Eng.

UNIT PACKAGE: 2



## 14678

Zinc

Thread M14-1.5  
Hex 16mm  
Lgth Under Hd: 20mm  
Washer Hd O.D.: 25mm

Fits the following  
M14-1.5 applications:

**AMC**

4 Cyl. VW 121 Eng. 79-77

**Chevrolet**

4 Cyl. 1.8 (Diesel) Eng. 81-On

**Chrysler Corp** (Exc. Imports)

4 Cyl. All 78-On

**Chrysler Corp.** Imports

4 Cyl. All 83-On

4 Cyl. K & W Engines

(built after 10-81) 82

**Ford Motor Co.**

4 & 6 Cyl. 98, 122, 140, 171 Eng.  
73-On

**Honda** 4 Cyl. Prelude 83-On

**Mazda** 4 Cyl. All 72-On

**Pontiac** 4 Cyl. 1.8 (Diesel) 83-On

**Volkswagen**

4 Cyl. All (Water Cooled Engine)  
74-On

UNIT PACKAGE: 5



## 20426

(90009-PY3-000)

Zinc & Yellow  
With Aluminum  
Gasket

Thread: M14-1.5  
Hex: 17mm  
Length Under Head: 15mm  
Washer Head O.D.: 24mm

Fits the following M14-1.5  
Applications:

**Acura & Honda 2000 - On**

UNIT PACKAGE: 5



## 19141

(6504018)

Plain With  
Rubber  
Washer Face  
Gasket

Thread: M14-1.50  
Hex: 13mm  
Length Under Head: 20mm  
Rubber Gasket O.D.: 28mm

Fits the following applications:  
**Chrysler** 2.0, 2.4, 2.7, 3.2, 3.5, 3.7 &  
4.7 Eng. 2000 - On

UNIT PACKAGE: 2



## 21650

(55568037)

Zinc

Thread: M14-1.5  
Hex: 10mm  
Length Under Head: 16mm  
Washer Head O.D.: 27mm

Fits the following applications:  
**Chevrolet** Cruze & Volt 2010 - On

UNIT PACKAGE: 2





**18026**

(601-997-02-30)  
Zinc

Thread: M14-1.5  
Hex: 13mm  
Length Under Head: 24mm  
Washer Head O.D.: 19mm

Fits the following applications:  
**Mercedes:** 300 Series

UNIT PACKAGE: 2



**21326**

(807016160,  
803916010)  
Zinc

Thread: M16-1.5 x 9mm  
Hex 14mm  
Washer Head O.D.: 24mm

Fits the following applications:  
**Subaru** Legacy & Outback 2.5L

UNIT PACKAGE: 2

**Auveco....**

**The World's Largest  
Supplier Of Body  
Hardware & Specialty  
Fasteners**



**15528**

Zinc

Thread M16.4-1.33 O.S.  
Hex 19mm  
Length Under Head: 13mm  
Washer Head O.D.: 26mm

Fits the Following M16.4 O.S.  
applications:  
**Nissan:** All (Exc. Sentra, Stanza &  
Pulsar w/FWD 62-On  
**Renault:** Fuego & LeCar 80-On

UNIT PACKAGE: 5



**15529**

Zinc

Thread: M18-1.5  
Hex: 19mm  
Length Under Head: 12mm  
Washer Head O.D.: 29mm

Fits the Following M18-1.5  
applications:  
**Chrysler:** All imports 70-On  
**Renault:** LeCar 79-76  
**Toyota:** All 75-On

UNIT PACKAGE: 5



**15530**

Plain

Thread: M20-1.5  
Hex: 15mm  
Length Under Head: 21mm  
Washer Head O.D.: 29mm

Fits the Following  
M20-1.5 applications:  
**Chevrolet Truck:**  
Luv 82-75

**Honda:**  
All exc. Prelude 73-On

**Subaru:** All 79-On  
UNIT PACKAGE: 5



**21041**

(028-103-059-A)  
Zinc

Thread: M24-1.5  
Drive: 10mm Allen  
Length Under Head: 10mm  
Head Diameter: 32mm

Fits the following applications:  
**Audi** Cabriolet, A6, A8, Avant,  
Quattro, RS6, S4, S6 & S8  
**VW** Phaeton 6.0L & V8 4.2L and  
Touareg 4.2L

UNIT PACKAGE: 1



**18027**

Zinc

Thread: M25-1.5  
Hex: 24mm  
Length Under Head: 13mm  
Washer Head O.D.: 35mm

Fits the following applications:  
**Toyota**

UNIT PACKAGE: 1

**Magnetic Oil Drain Plugs (With Gaskets)**  
Zinc Plated



Type 1



Type 2



Type 3

Auveco Part No.	Type	Thread Size	Hex	Length Under Head	Finish	Unit Pkg.
<b>19365</b>	3	1/2"-20	3/4"	43/64"	Zinc	1
<b>17145</b>	1	1/2"-20 Single Oversize	3/4"	13/16"	Zinc	2
<b>17146</b>	1	1/2"-20 Double Oversize	3/4"	13/16"	Zinc & Yellow	2
<b>17147</b>	1	1/2"-20 Triple Oversize	3/4"	13/16"	Black Zinc	2
<b>17148</b>	2	12mm-1.75	13mm	19mm	Zinc	2

**Oversize "Piggy-Back" Drain Plugs With Gasket**



**11782**

1/2"-20 Single Oversize  
Zinc

UNIT PACKAGE: 5

**11783**

1/2"-20 Double Oversize  
Zinc & Yellow

UNIT PACKAGE: 5

**Oversize Oil Pan Drain Plugs With Fibre Gaskets Self-Tapping**



Metric













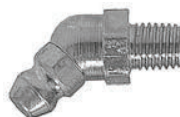

Standard













Auveco Part No.	Size	Finish	Unit Pkg.
<b>19587</b>	1/2"-20 Single Oversize	Zinc	5
<b>18121</b>	1/2"-20 Double Oversize	Zinc & Yellow	5
<b>18122</b>	1/2"-20 Triple Oversize	Black Zinc	5
<b>8285</b>	5/8"-18 Single Oversize	Zinc	5
<b>8286</b>	11/16"-20 Single Oversize	Zinc	5
<b>8288</b>	3/4"-16 Single Oversize	Zinc	5
<b>8289</b>	7/8"-14 Single Oversize	Zinc	5
<b>19618</b>	M12-1.25 Single Oversize	Zinc	5
<b>20759</b>	M12-1.50 Single Oversize	Zinc	5
<b>19619</b>	M12-1.75 Single Oversize	Zinc	5
<b>19620</b>	M14-1.50 Single Oversize	Zinc	5

# Sec. 13

## GREASE FITTINGS (Also Available In Large Bulk Quantities)

<p><b>Ref. No:</b> 1792</p>  <p>1/4"-28, Straight Thread Length: 9/64" Overall Length: 1/2" Ball Check, Plated</p> <p><b>15055</b> Unit Pkg: 50 <b>15074</b> Unit Pkg: 250 <b>15075</b> Unit Pkg: 500 <b>15440</b> Unit Pkg: 1000</p>	<p><b>Ref. No:</b> 5530</p>  <p>1/4"-28, Straight Self-Tapping Overall Length: 9/16" Ball Check, Plated</p> <p><b>15000</b> Unit Pkg: 50 <b>15068</b> Unit Pkg: 250 <b>15069</b> Unit Pkg: 500</p>	<p><b>Ref. No:</b> 1636</p>  <p>1/4"-28, 45° Thread Length: .3" Overall Length: 1" Ball Check, Plated</p> <p><b>15056</b> Unit Pkg: 25 <b>15076</b> Unit Pkg: 100 <b>15077</b> Unit Pkg: 250 <b>15441</b> Unit Pkg: 1000</p>
<p><b>Ref. No:</b> 1641</p>  <p>1/4"-28, Straight Thread Length: 7/32" Overall Length: 9/16" Ball Check, Plated</p> <p><b>9257</b> Unit Pkg: 50 <b>15100</b> Unit Pkg: 250 <b>15101</b> Unit Pkg: 500 <b>15415</b> Unit Pkg: 1000</p>	<p><b>Ref. No:</b> 1743</p>  <p>1/4" Drive Fit Straight Overall Length: 1/2" Ball Check, Plated</p> <p><b>15054</b> Unit Pkg: 25 <b>15072</b> Unit Pkg: 100 <b>15073</b> Unit Pkg: 250 <b>15439</b> Unit Pkg: 1000</p>	<p><b>Ref. No:</b> 1665</p>  <p>1/4"-28, 65° Overall Length: 25/32" Ball Check, Plated</p> <p><b>15053</b> Unit Pkg: 25 <b>15070</b> Unit Pkg: 100 <b>15071</b> Unit Pkg: 250 <b>15438</b> Unit Pkg: 1000</p>
<p><b>Ref. No:</b> 1652</p>  <p>1/4"-28 Straight Overall Length: 11/16" Ball Check, Plated</p> <p><b>9258</b> Unit Pkg: 50 <b>15102</b> Unit Pkg: 250 <b>15103</b> Unit Pkg: 500 <b>15416</b> Unit Pkg: 1000</p>	<p><b>Ref. No.</b> 1952</p>  <p>1/4" Drive Fit, Straight Overall Length: 27/64" No Check Valve Plated</p> <p><b>15065</b> Unit Pkg: 50 <b>15094</b> Unit Pkg: 250 <b>15450</b> Unit Pkg: 1000</p>	<p><b>Ref. No:</b> 1911</p>  <p>1/4"-28, 90° Overall Length: 45/64" Ball Check, Plated</p> <p><b>9261</b> Unit Pkg: 25 <b>15108</b> Unit Pkg: 100 <b>15109</b> Unit Pkg: 250</p>
<p><b>Ref. No.</b> 1680</p>  <p>1/4"-28, Straight Overall Length: 15/16" Ball Check, Plated</p> <p><b>9259</b> Unit Pkg: 25 <b>15104</b> Unit Pkg: 100 <b>15417</b> Unit Pkg: 1000</p>	<p><b>Ref. No:</b> 1637</p>  <p>1/4"-28, 45° Overall Length: 29/32" Ball Check, Plated</p> <p><b>9260</b> Unit Pkg: 25 <b>15106</b> Unit Pkg: 100 <b>15107</b> Unit Pkg: 250 <b>15418</b> Unit Pkg: 1000</p>	<p><b>Ref No:</b> 5590</p>  <p>1/4"-28, 90° Self-Tapping Overall Length: 43/64" Ball Check, Plated</p> <p><b>19176</b> Unit Pkg: 25 <b>19177</b> Unit Pkg: 100 <b>19178</b> Unit Pkg: 250</p>

**GREASE FITTINGS**  
(Also Available In Large Bulk Quantities)

<p><b>Ref No:</b> <b>1610</b></p>  <p>1/8" Pipe, St. Overall Length: 5/8" Ball Check, Plated</p> <p><b>9262</b> Unit Pkg: 50 <b>15110</b> Unit Pkg: 250 <b>15111</b> Unit Pkg: 500 <b>15420</b> Unit Pkg: 1000</p>	<p><b>Ref. No:</b> <b>1688</b></p>  <p>1/8" Pipe, 45° Overall Length: 1" Ball Check, Plated</p> <p><b>9264</b> Unit Pkg: 25 <b>15114</b> Unit Pkg: 100 <b>15115</b> Unit Pkg: 250 <b>15422</b> Unit Pkg: 1000</p>	<p><b>Ref. No:</b> <b>1612</b></p>  <p>1/8" Pipe, 65° Overall Length: 7/8" Ball Check, Plated</p> <p><b>9265</b> Unit Pkg: 25 <b>15116</b> Unit Pkg: 100 <b>15117</b> Unit Pkg: 250 <b>15423</b> Unit Pkg: 1000</p>
<p><b>Ref No:</b> <b>1607</b></p>  <p>1/8" Pipe, St. Overall Length: 1-1/4" Ball Check, Plated</p> <p><b>9267</b> Unit Pkg: 25 <b>15120</b> Unit Pkg: 100 <b>15121</b> Unit Pkg: 250</p>	<p><b>Ref. No:</b> <b>5570</b></p>  <p>1/8" Pipe, St. Self-Tapping Overall Length: 39/64" Ball Check, Plated Nominal Hole Size: 3/8"</p> <p><b>15066</b> Unit Pkg: 25 <b>15096</b> Unit Pkg: 100 <b>15097</b> Unit Pkg: 250</p>	<p><b>Ref. No:</b> <b>1613</b></p>  <p>1/8" Pipe, 90° Overall Length: 53/64" Ball Check, Plated</p> <p><b>9266</b> Unit Pkg: 25 <b>15118</b> Unit Pkg: 100 <b>15119</b> Unit Pkg: 250 <b>15424</b> Unit Pkg: 1000</p>
<p><b>Ref. No:</b> <b>1728</b></p>  <p>3/16" Drive Fit, St. Overall Length: 1/2" Ball Check, Plated</p> <p><b>15060</b> Unit Pkg: 50 <b>15084</b> Unit Pkg: 250 <b>15085</b> Unit Pkg: 500</p>	<p><b>Ref. No:</b> <b>1711</b></p>  <p>5/16"-24, Straight Overall Length: 5/8" Ball Check, Plated</p> <p><b>15057</b> Unit Pkg: 25 <b>15078</b> Unit Pkg: 100 <b>15079</b> Unit Pkg: 250</p>	<p><b>Ref. No:</b> <b>1608</b></p>  <p>5/16" Drive Fit, St. Overall Length: 9/16" Ball Check, Plated</p> <p><b>15061</b> Unit Pkg: 50 <b>15086</b> Unit Pkg: 250 <b>15087</b> Unit Pkg: 500 <b>15446</b> Unit Pkg: 1000</p>
<p><b>Ref. No:</b> <b>1710</b></p>  <p>3/8"-24, Straight Overall Length: 5/8" Ball Check, Plated</p> <p><b>15058</b> Unit Pkg: 25 <b>15080</b> Unit Pkg: 100</p>	<p><b>Ref. No:</b> <b>1627</b></p>  <p>1/4" Pipe, St. Overall Length: 27/32" Ball Check, Plated</p> <p><b>15059</b> Unit Pkg: 25 <b>15082</b> Unit Pkg: 100 <b>15083</b> Unit Pkg: 250 <b>15444</b> Unit Pkg: 1000</p>	<p><b>Ref. No:</b> <b>1629</b></p>  <p>1/4" Pipe, 65° Overall Length: 1" Ball Check, Plated</p> <p><b>15062</b> Unit Pkg: 10 <b>15088</b> Unit Pkg: 50 <b>15089</b> Unit Pkg: 100</p>



# Sec. 13

## METRIC GREASE FITTINGS (Also Available In Large Bulk Quantities)

**Ref No:**  
8601



6mm-1.00, Straight  
DIN 71412  
Overall Length: 14mm  
Ball Check, Plated

**11097** Unit Pkg: 5  
**15122** Unit Pkg: 50  
**15123** Unit Pkg: 100  
**15426** Unit Pkg: 1000

**Ref. No:**  
7045



6mm-1.00, 45°  
Overall Length: 22mm  
Ball Check, Plated

**11775** Unit Pkg: 10  
**15132** Unit Pkg: 50  
**15133** Unit Pkg: 100  
**15431** Unit Pkg: 1000

**Ref No:**  
7090



6mm-1.00, 90°  
Overall Length: 18mm  
Ball Check, Plated

**11776** Unit Pkg: 10  
**15134** Unit Pkg: 50  
**15135** Unit Pkg: 100

**Ref No:**  
8901



8mm-1.00, Straight  
DIN 71412  
Overall Length: 15mm  
Ball Check, Plated

**11098** Unit Pkg: 5  
**15124** Unit Pkg: 50  
**15125** Unit Pkg: 100

**Ref No:**  
7445



8mm-1.00, 45°  
Overall Length: 23mm  
Ball Check, Plated

**11777** Unit Pkg: 10  
**15136** Unit Pkg: 50  
**15137** Unit Pkg: 100

**Ref No:**  
7490



8mm-1.00, 90°  
DIN 71412  
Overall Length: 18mm  
Ball Check, Plated

**11099** Unit Pkg: 5  
**15126** Unit Pkg: 50  
**15127** Unit Pkg: 100

**Ref No:**  
9201



8mm-1.25, Straight  
Overall Length: 15mm  
Ball Check, Plated

**11778** Unit Pkg: 10  
**15138** Unit Pkg: 50  
**15139** Unit Pkg: 100  
**15434** Unit Pkg: 1000

**Ref No:**  
7545



8mm-1.25, 45°  
Overall Length: 23mm  
Ball Check, Plated

**11779** Unit Pkg: 10  
**15140** Unit Pkg: 50  
**15141** Unit Pkg: 100

**Ref No:**  
7590

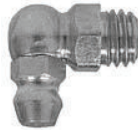

8mm-1.25, 90°  
Overall Length: 18mm  
Ball Check, Plated

**11780** Unit Pkg: 10  
**15142** Unit Pkg: 50  
**15143** Unit Pkg: 100  
**15436** Unit Pkg: 1000

**Ref No:**  
9301



10mm-1.00, Straight  
DIN 71412  
Overall Length: 15mm  
Ball Check, Plated

**11100** Unit Pkg: 5  
**15128** Unit Pkg: 50  
**15129** Unit Pkg: 100

**Ref No:**  
9345



10mm-1.00, 45°  
Overall Length: 23mm  
Ball Check, Plated

**15067** Unit Pkg: 25  
**15098** Unit Pkg: 100  
**15099** Unit Pkg: 250

**Ref No:**  
9390



10mm-1.00, 90°  
DIN 71412  
Overall Length: 19mm  
Ball Check, Plated

**11101** Unit Pkg: 5  
**15130** Unit Pkg: 50  
**15131** Unit Pkg: 100

**Ref. No:**  
9501



10mm-1.5 Straight  
Overall Length: 15mm  
Ball Check, Plated

**17555** Unit Pkg: 50

### STAINLESS STEEL WITH BALL CHECK 303 Series Body • 420 Series Ball • 302 Series Spring

**Ref. No:**  
8036



6mm-1.00, Straight  
Overall Length: 14mm

UNIT PACKAGE: 5

**17155**

**Ref. No:**  
8058



8mm-1.00, Straight  
Overall Length: 15mm

UNIT PACKAGE: 5

**17156**

**4-Way Grease Fitting Tool**

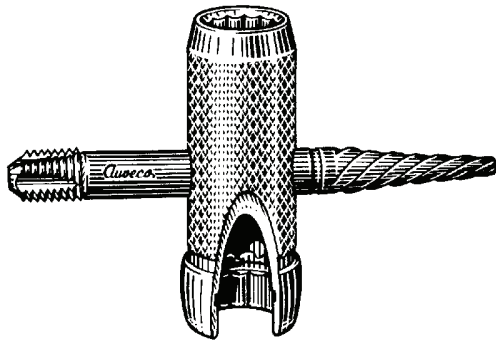

**15694**

For 1/8" NPT fittings. Tap repairs 1/8" NPT threads. Wrench removes 7/16" and 3/8" hex fittings and plugs. Installs new 1/8" NPT fittings. "Easy Out" removes broken fittings.

UNIT PACKAGE: 1

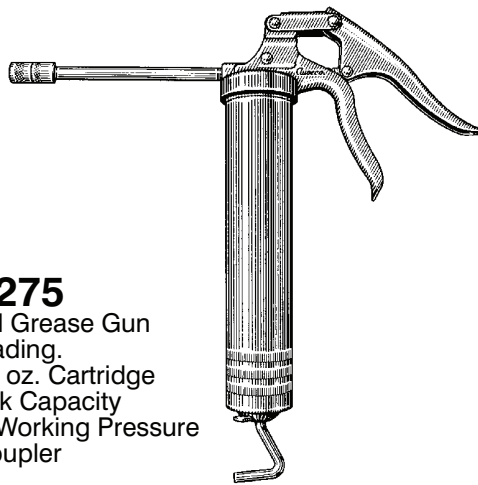

**16275**

One-Hand Grease Gun  
3-Way Loading.  
Uses 14.5 oz. Cartridge  
16 oz. Bulk Capacity  
2500 PSI Working Pressure  
3 Claw Coupler  
Blue

UNIT PACKAGE: 1

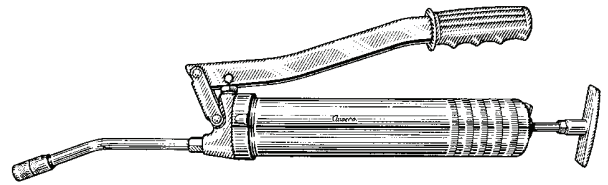

**16277**

Professional Grease Gun  
Delivers Grease At Various Lever Openings  
3-Way Loading  
Uses 14.5 oz. Cartridge  
16 oz. Bulk Capacity  
Variable Pressure  
4 Claw Coupler  
Zinc With Black Rubber Grip

UNIT PACKAGE: 1

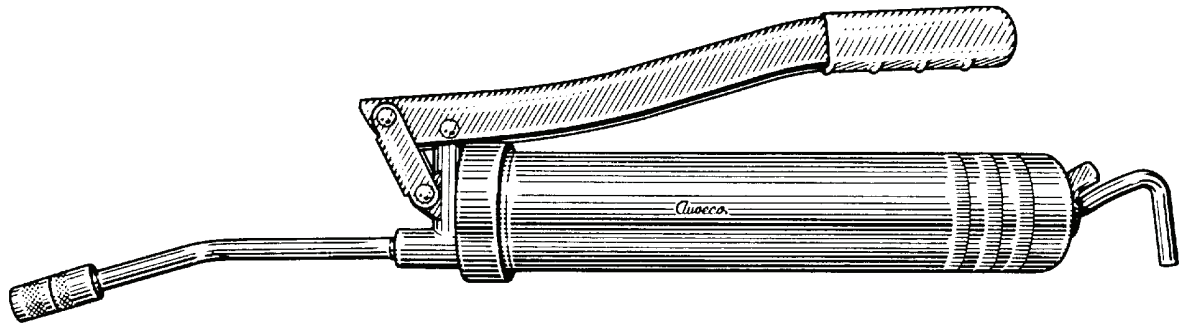

**16276**

Heavy Duty Grease Gun  
3-Way Loading  
Uses 14.5 oz. Cartridge  
16 oz. Bulk Capacity  
10,000 PSI Working Pressure  
3 Claw Coupler  
Blue With Orange Vinyl Grip

UNIT PACKAGE: 1

**Sec. 13**

**GREASE GUN ACCESSORIES & PIPE PLUGS**



**15688**

Grease Gun Coupler  
With Ball Check

Fits 1/8" NPT Threads  
For hand operated lube equipment. Working pressure:  
3,000 PSI  
Overall Length: 1-3/8"

UNIT PACKAGE: 1



**15689**

Heavy Duty  
Grease Gun  
Coupler  
With Ball Check

Fits 1/8" NPT Threads  
For hand operated lube equipment only.  
Working pressure: 5,000 PSI  
Overall Length: 1-7/16"

UNIT PACKAGE: 1

**Grease Gun Hoses  
1/8" NPT Male Fittings**



**15691**

12"  
3000 PSI

UNIT PKG: 1

**15692**

18"  
3000 PSI

UNIT PKG: 1

**16279**

12"  
5800 PSI

UNIT PKG: 1

**16280**

18"  
5800 PSI

UNIT PKG: 1

**Grease Fitting Caps**

Polyethylene caps that snap over fittings to seal out dirt and moisture. Integral ring keeps cap in place during servicing.



**18109**

Black

U.P. 50

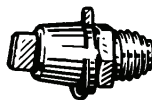

**18110**

Red

U.P. 50

**18111**

Yellow

U.P. 50

**Socket Head Pipe Plugs**

Cold Rolled Steel  
Plain Finish



**Hex Head Pipe Plugs**

Cold Rolled Steel  
Plain Finish



Auveco  
Part No.

O.E.M.  
No.

Pipe  
Size

Unit  
Pkg.

**9278**.....GM: 444613 .....1/8-27 .....25  
**9279**.....GM: 444619, .....1/4-18 .....25  
GM: 444620

Auveco  
Part No.

O.E.M.  
No.

Pipe  
Size

Unit  
Pkg.

**9282**.....GM: 9427882 .....1/8-27 .....25  
**9283**.....GM: 444776 .....1/4-18 .....25  
**9284**.....GM: 444782 .....3/8-18 .....25  
**9285**.....GM: 444667, .....1/2-14 .....25  
GM: 444789

# BRASS FITTINGS

## Inverted Flare Fittings



**Inverted Nut (Brass)**

Auveco Part No.	Tube Size	Unit Pkg
30	3/16"	10
31	1/4"	10
32	5/16"	10
33	3/8"	10



**Male Connector (Brass)**

Auveco Part No.	Tube Size	Pipe Thread	Unit Pkg
49	1/8"	1/8"	5
50	3/16"	1/8"	5
51	1/4"	1/8"	5
52	5/16"	1/8"	5
53	3/8"	1/4"	5



**90° Male Elbow (Brass)**

Auveco Part No.	Tube Size	Pipe Thread	Unit Pkg
75	3/16"	1/8"	5
76	1/4"	1/8"	5
77	5/16"	1/8"	5
78	3/8"	1/4"	5



**Inverted Nut (Steel)**

Auveco Part No.	Tube Size	Unit Pkg
35	1/8"	10
36	3/16"	10
37	1/4"	10
38	5/16"	10
39	3/8"	10

Continuation of Male Connector table:



**45° Male Elbow (Brass)**

Auveco Part No.	Tube Size	Pipe Thread	Unit Pkg
90	3/16"	1/8"	5
91	1/4"	1/8"	5



**Steel Plug**

Auveco Part No.	Tube Size	Unit Pkg
45	3/16"	10
46	1/4"	10
47	5/16"	10



**Union (Brass)**

Auveco Part No.	Tube Size	Unit Pkg
69	3/16"	5
70	1/4"	5
72	3/8"	5
73	1/2"	5



**Male Branch (Brass)**

Auveco Part No.	Tube Size	Pipe Thread	Unit Pkg
96	3/16"	1/8"	5



**Sleeve (Brass)**

Auveco Part No.	Tube Size	Unit Pkg
101	1/8"	25
102	3/16"	25
103	1/4"	25
104	5/16"	25
105	3/8"	25
107	1/2"	10

### Compression Fittings



**Nut (Brass)**

Auveco Part No.	Tube Size	Unit Pkg
110	1/8"	10
111	3/16"	10
112	1/4"	10
113	5/16"	10
114	3/8"	10
116	1/2"	10



**Male Elbow (Brass)**

Auveco Part No.	Tube Size	Pipe Thread	Unit Pkg
158	1/8"	1/8"	5
159	3/16"	1/8"	5
161	1/4"	1/4"	5
162	5/16"	1/8"	5
163	5/16"	1/4"	5
164	3/8"	1/8"	5
165	3/8"	1/4"	5
167	1/2"	3/8"	5
168	1/2"	1/2"	5

**Union: (Brass)**



Auveco Part No.	Tube Size	Unit Pkg
150	1/8"	5
151	3/16"	5
152	1/4"	5
153	5/16"	5
154	3/8"	5
155	1/2"	5

(Continued on next page)

# Sec. 13

## BRASS FITTINGS Compression Fittings (continued)



Male Connector  
(Brass)

Auveco Part No.	Tube Size	Pipe Thread	Unit Pkg.
119	1/8"	1/8"	5
120	3/16"	1/8"	5
121	1/4"	1/8"	5
122	1/4"	1/4"	5
123	5/16"	1/8"	5
124	5/16"	1/4"	5
125	3/8"	1/8"	5
126	3/8"	1/4"	5
127	3/8"	3/8"	5
128	1/2"	3/8"	5



Male Run Tee  
(Brass)

Auveco Part No.	Tube Size	Pipe Thread	Unit Pkg.
172	1/4"	1/8"	5



Male Branch Tee  
(Brass)

Auveco Part No.	Tube Size	Pipe Thread	Unit Pkg.
181	3/16"	1/8"	5
182	1/4"	1/8"	5
185	1/2"	3/8"	5



Adapter Tee  
(Brass)

Auveco Part No.	Tube Size	Ext. Pipe Thd.	Int. Pipe Thd.
177	3/16"	1/8"	1/8"
178	1/4"	1/8"	1/8"

UNIT PACKAGE: 5

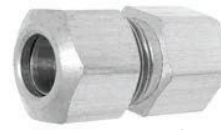

Female Connector  
(Brass)

Auveco Part No.	Tube Size	Pipe Thread	Unit Pkg.
134	1/8"	1/8"	5
135	3/16"	1/8"	5
136	1/4"	1/8"	5
137	5/16"	1/8"	5



Union Tee  
(Brass)

Auveco Part No.	Tube Size	Unit Pkg.
186	3/16"	5
187	1/4"	5
188	5/16"	5
189	3/8"	5

### Double Compression (Threaded Sleeve) Fittings



Nut  
(Brass)

Auveco Part No.	Tube Size	Unit Pkg.
192	1/8"	10
193	3/16"	10
194	1/4"	10



Male Connector  
(Brass)

Auveco Part No.	Tube Size	Pipe Thread	Unit Pkg.
198	1/8"	1/8"	5
200	1/4"	1/8"	5
201	5/16"	1/8"	5



Male Elbow  
(Brass)

Auveco Part No.	Tube Size	Pipe Thread	Unit Pkg.
205	1/8"	1/8"	5
206	3/16"	1/8"	5

### S.A.E. 45° Flared Tube Fittings



SAE Flare Nut (Long)  
(Brass)

Auveco Part No.	Tube Size	Unit Pkg.
211	3/16"	5
212	1/4"	5



SAE Flare Nut (Short)  
(Brass)

Auveco Part No.	Tube Size	Unit Pkg.
221	1/4"	5
223	3/8"	5
224	1/2"	5



Male Elbow  
(Brass)

Auveco Part No.	Tube Size	Pipe Thread	Unit Pkg.
228	1/8"	1/8"	5
229	3/16"	1/8"	5
230	1/4"	1/8"	5
231	1/4"	1/4"	5
232	5/16"	1/8"	5
233	5/16"	1/4"	5
234	3/8"	1/4"	5
235	3/8"	1/8"	5
236	3/8"	3/8"	5

# BRASS FITTINGS

## S.A.E. 45° FLARED TUBE FITTINGS (Continued)



Union  
(Brass)

Auveco Part No.	Tube Size	Unit Pkg.
245	5/16"	5
246	3/8"	5
247	1/2"	5



Male Connector  
(Brass)

Auveco Part No.	Tube Size	Pipe Thread	Unit Pkg.
261	1/4"	1/8"	5
262	1/4"	1/4"	5
263	5/16"	1/8"	5
264	5/16"	1/4"	5
265	3/8"	1/4"	5
266	3/8"	1/8"	5
268	1/2"	3/8"	5
269	1/2"	1/2"	5

**You Can  
Help Auveco  
Help You.**

**E-mail Your  
New Item  
Suggestions**

**To:  
mail@auveco.com**



Cap  
(Brass)

Auveco Part No.	Pipe Thread	Unit Pkg.
287	1/8"	5
288	1/4"	5

### Pipe Fittings



Hex Head Plug  
(Brass)

Auveco Part No.	Pipe Thread	Unit Pkg.
295	1/8"	5
296	1/4"	5
297	3/8"	5
298	1/2"	5



Close Nipple  
(Brass)

Auveco Part No.	Lgth.	Pipe Thread	Unit Pkg.
305	3/4"	1/8"	5
306	7/8"	1/4"	5
307	1"	3/8"	5
308	1-1/8"	1/2"	5



Slotted Plug  
(Brass)

Auveco Part No.	Pipe Thread	Unit Pkg.
289	1/8"	5
290	1/4"	5



Bushing  
(Brass)

Auveco Part No.	Ext. Pipe Thd.	Int. Pipe Thd.	Unit Pkg.
299	1/4"	1/8"	5
300	3/8"	1/8"	5
301	3/8"	1/4"	5
302	1/2"	1/8"	5
303	1/2"	1/4"	5
304	1/2"	3/8"	5



Long Nipple  
(Brass)

Auveco Part No.	Lgth.	Pipe Thread	Unit Pkg.
309	1-1/2"	1/8"	5
310	2"	1/8"	5
311	2-1/2"	1/8"	5
313	1-1/2"	1/4"	5
314	2"	1/4"	5
315	2-1/2"	1/4"	5



Square Head Plug  
(Brass)

Auveco Part No.	Pipe Thread	Unit Pkg.
291	1/8"	5
292	1/4"	5
293	3/8"	5
294	1/2"	5

(Continued on next page)

Refer to page 236 for "Pipe Thread Identification"

# Sec. 13

# BRASS FITTINGS

## Pipe Fittings (continued)



Hex Nipple  
(Brass)

Auveco Part No.	Pipe Thd. A	Pipe Thd. B	Unit Pkg.
316	1/8"	1/8"	5
317	1/4"	1/4"	5
318	1/4"	1/8"	5
319	3/8"	3/8"	5
320	3/8"	1/8"	5
321	3/8"	1/4"	5
322	1/2"	1/2"	5



Adaptor  
(Brass)

Auveco Part No.	Pipe Thd. A	Pipe Thd. B	Unit Pkg.
325	1/8"	1/8"	5
326	1/4"	1/8"	5
327	1/4"	1/4"	5
328	3/8"	1/4"	5
329	3/8"	3/8"	5
330	1/2"	3/8"	5



Coupling  
(Brass)

Auveco Part No.	Pipe Thread	Unit Pkg.
331	1/8"	5
332	1/4"	5
333	3/8"	5
334	1/2"	5



Reducing Coupling  
(Brass)

Auveco Part No.	Pipe Thd. A	Pipe Thd. B	Unit Pkg.
335	1/4"	1/8"	5
336	3/8"	1/8"	5
337	3/8"	1/4"	5
339	1/2"	3/8"	5

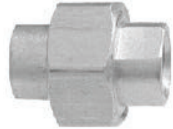

Union  
(Brass)

Auveco Part No.	Pipe Thread	Unit Pkg.
340	1/8"	5
341	1/4"	5



90° Street Elbow  
(Brass)

Auveco Part No.	Int. Pipe Thd.	Ext. Pipe Thd.	Unit Pkg.
342	1/8"	1/8"	5
343	1/4"	1/4"	5
344	3/8"	3/8"	5
345	1/4"	1/8"	5



45° Street Elbow  
(Brass)

Auveco Part No.	Pipe Thread	Unit Pkg.
347	1/8"	5
348	1/4"	5
349	3/8"	5



90° Pipe Elbow  
(Brass)

Auveco Part No.	Int. Pipe Thd.	Ext. Pipe Thd.	Unit Pkg.
350	1/8"	1/8"	5
351	1/4"	1/4"	5
352	3/8"	3/8"	5



Cross  
(Brass)

Auveco Part No.	Pipe Thread	Unit Pkg.
353	1/8"	5
354	1/4"	5



Tee  
(Brass)

Auveco Part No.	Pipe Thread	Unit Pkg.
355	1/8"	5
356	1/4"	5
357	3/8"	5



Male Branch Tee  
(Brass)

Auveco Part No.	Pipe Thread	Unit Pkg.
358	1/8"	5



Street Tee  
(Brass)

Auveco Part No.	Pipe Thread	Unit Pkg.
359	1/8"	5
360	1/4"	5

## Pipe Thread Identification



1/8"



1/4"



3/8"



1/2"

# BRASS FITTINGS

## Drain Cocks and Valves



External Seat  
(Brass)

Auveco Part No.	Pipe Thread	Unit Pkg.
<b>370</b> .....	1/8"	5
<b>371</b> .....	1/4"	5
<b>372</b> .....	3/8"	5

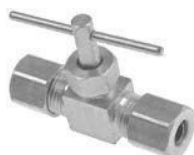

Compression Line  
(Brass)

Auveco Part No.	Tube Size	Unit Pkg.
<b>385</b> .....	1/4"	3

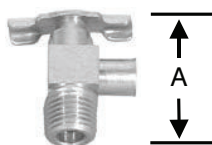

Angle Bib Drain  
(Brass)

Auveco Part No.	Pipe Thd.	A	Unit Pkg.
<b>374</b> .....	1/4"	1-11/16"	5



Ground Plug Drain  
(Brass)

Auveco Part No.	Pipe Thread	Unit Pkg.
<b>405</b> .....	1/8"	5
<b>406</b> .....	1/4"	5

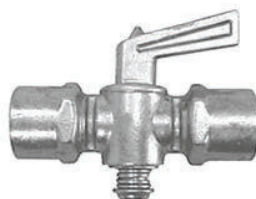

Female Pipe  
Ground Plug Line  
(Brass)

Auveco Part No.	Pipe Thread	Unit Pkg.
<b>399</b> .....	1/8"	3
<b>401</b> .....	1/4"	3



Compression Line  
Ground Plug  
(Brass)

Auveco Part No.	Tube Size	Unit Pkg.
<b>389</b> .....	5/16"	3



SAE Angle  
(Brass)

Auveco Part No.	Tube Size	Pipe Thd.
<b>395</b> .....	1/4"	1/8"
<b>398</b> .....	3/8"	1/4"

UNIT PACKAGE: 3



Multiple Shut-Off Valves  
Stem Short  
(Brass)

Auveco Part No.	Desc.
<b>404</b>	3 Way 1/4 Female 3 Ends

UNIT PACKAGE: 1

**View the Auveco Catalog on-line at [www.auveco.com](http://www.auveco.com). You can search by Auveco part number, description, OEM number and competitive part number.**



# Sec. 13

# BRASS FITTINGS

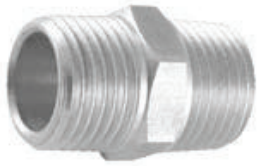

Ball End  
Joint Adapter To  
Taper Male Pipe

Auveco Part No.	Male N.P.S. Thread	Male N.P.T. Thread	Unit Pkg.
445	1/4"	1/4"	10
448	1/2"	3/8"	5

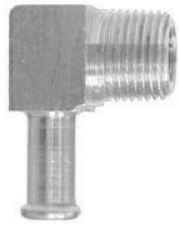

Beaded Hose Barb  
90° Elbow Tube To Male Pipe

Auveco Part No.	I.D. Hose Size	Pipe Thread	Unit Pkg.
461	1/2"	3/8"	3
462	5/8"	1/4"	3
463	5/8"	3/8"	3
464	5/8"	1/2"	3
465	3/4"	1/2"	2

Beaded Hose Barb  
Tube To Male Pipe



Auveco Part No.	I.D. Hose Size	Pipe Thread	Unit Pkg.
413	3/8"	3/8"	5
415	1/2"	3/8"	5
416	5/8"	3/8"	5
417	5/8"	1/2"	5
418	3/4"	1/2"	5

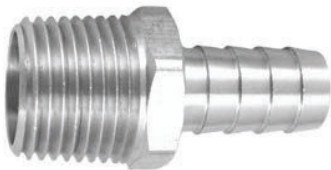

Hose Barb To  
Taper Male Pipe

Auveco Part No.	I.D. Hose Size	Pipe Thread	Unit Pkg.
424	3/16"	1/8"	10
425	1/4"	1/8"	10
426	1/4"	1/4"	10
427	1/4"	3/8"	5
428	5/16"	1/8"	10
429	5/16"	1/4"	5
430	3/8"	1/8"	10
431	3/8"	1/4"	10
432	3/8"	3/8"	5
433	1/2"	1/4"	5
434	1/2"	3/8"	5
435	1/2"	1/2"	5

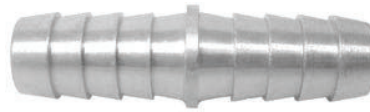

Barbed Hose Coupler

Auveco Part No.	I.D. Hose Size	Overall Length	Unit Pkg.
*419	3/16"	1.44"	5
420	1/4"	2.00"	5
421	5/16"	2.00"	5
422	3/8"	2.00"	5
423	1/2"	2.00"	5

\* 3 Barb Design

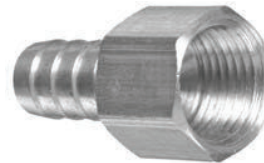

Hose Barb To  
Taper Female Pipe

Auveco Part No.	I.D. Hose Size	Pipe Thread	Unit Pkg.
437	1/4"	1/4"	5
438	5/16"	1/4"	5
439	3/8"	1/8"	5
440	3/8"	1/4"	5
441	3/8"	3/8"	5
442	1/2"	3/8"	5
443	1/2"	1/2"	5



Hose Barb 90° Elbow  
Tube To Male Pipe

Auveco Part No.	I.D. Hose Size	Pipe Thread	Unit Pkg.
455	1/4"	1/8"	5
456	1/4"	1/4"	5
457	3/8"	1/4"	5